

Valeo-E

Mono-pipe ventilation exhaust centrifugal fans

Use

- Extract ventilation systems installed in high-rise buildings and premises.
- For buildings with mono-pipe ventilation system.
- For mounting in kitchens and bathrooms.
- Surface wall or ceiling mounting.



Air flow:
up to 150 m³/h
42 l/s



Power:
from 12 W



Noise level:
from 27 dBA



Design

- The fan consists of the plastic casing for surface mounting and exhaust ventilation unit Valeo with a flat front panel.
- The casing is made of durable ABS plastic and fitted with a gravity back-draft damper to prevent backdrafting.



- The front panel is made of snow-white UV-resistant plastic.
- Filter with filter class G4 for motor, impeller and ductwork system protection against soiling.
- The filter is easily accessible for service operations.
- Due to modern design and various colour modifications the front panel matches well with any interior.
- The casing is equipped with oblong slotted joints to facilitate mounting of the casing in true vertical position.
- Power is supplied to the fan through a sealed electric lead-in on the

casing and the ventilation unit is equipped with an airtight terminal block for connection to the wiring system

- Exhaust spigot diameter 80 mm.
- Ingress protection rating IP55.

Motor

- Two- or three-speed motor with centrifugal impeller. Minimum energy demand.
- Galvanized steel impeller with forward curved blades.
- Automatic maintaining of constant air flow depending on variable air resistance of the duct.
- Balanced impeller ensures low-noise operation.
- Best aerodynamic characteristics due to special scroll casing design.
- Ball bearings provide long service life.
- The ventilation unit with motor is fixed inside the casing with special latches.

Speed control

- Step speed control with an external speed controller, e.g. **CDP-3/5** model which is available upon order.
- Wide range of intellectual controls programmable by set parameters (timer, adjustable timer, internal switch, photo sensor, humidity sensor).

Mounting

- Flexible air duct connected to ductwork system and wiring are routed to the fan through wall or ceiling.
- After finishing works a flexible air duct is fixed on the fan spigot with clamps.

Designation key

Series	Front panel	Air capacity according to speed	Option
Valeo-E	_: white plastic Hi-Tech: natural aluminium; Hi-Tech Gold: aluminium in gold; Hi-Tech Chrome: aluminium in chrome; Platinum: grey aluminium lacquer ; Vintage: painted vintage; Gold: electroplating on plastic in gold; Chrome: electroplating on plastic in chrome.	35/60; 35/100; 35/60/100; 60/100; 60/100/150;	K: fire damper; T: timer; TR: regulated timer; I: interval switch; F: photoelectronics; H: humidity sensor.

Accessories



Filter Speed controller BlauFlex AN Clamp

- Power is supplied to the fan through a sealed electric lead-in on the casing.
- The casing is installed at site with dowels and is adjusted vertically with oblong slotted joints.
- The ventilation unit connected to wiring system is installed in the mounted and fixed casing.

Options for 2 speed fan models

- Timer (Valeo-E...T)**
Depending on wiring connection the fan is off or runs permanently at low speed. The fan is turned to higher speed with external switch 50 s after activation. After turning the switch off the fan continues operating within 6 min at higher speed and then reverts to default operation mode.
- Adjustable timer (Valeo-E...TR)**
Depending on wiring connection the fan is off or runs permanently at low speed. If the fan is turned on with an external switch it switches to higher speed 0 to 150 s after switch activation. After turning the fan off it continues running at higher speed 2 to 30 minutes and then reverts to previous mode. The fan run-out time and delay time for higher speed are regulated with the internal regulator.

- Interval switch (Valeo-E...I)**
Depending on wiring connection the fan is off or runs permanently at low speed. In interval mode regulated from 0.5 to 15 hours the fan switches periodically to higher speed for 10 minutes. The switch interval is adjusted with the internal regulator. If light in the room is turned with the external switch the fan switches to higher speed in 50 s. After light is off the fan reverts to interval mode operation.
- Photo sensor (Valeo-E...F)**
Depending on wiring connection the fan is off or runs permanently at low speed. If light in the room is turned with the external switch the fan switches to higher speed in 50 s. After light is off the fan continues running at higher speed within 2 to 30 min and then reverts to default operating mode. The fan run-out time and delay time for higher speed are regulated with the internal regulator.
- Humidity sensor (Valeo-E...H)**
Depending on wiring connection the fan is off or runs permanently at low speed. The fan switches to higher speed as relative humidity in the room increases from 60 % up to 90 % and switches off as humidity drops by 10 % below set level. If light in the room is turned on the fan switches to higher speed in 50 s. The run-out time is set by the internal regulator from 2 to 30 minutes.

Front panel modifications

- The standard snow white front panel can be replaced by the following models:



Platinum
Grey metallic



Hi-Tech
Natural brushed aluminium



Hi-Tech Gold
Natural gold-coloured aluminium



Hi-Tech Chrome
Natural mirror aluminium

Mounting example

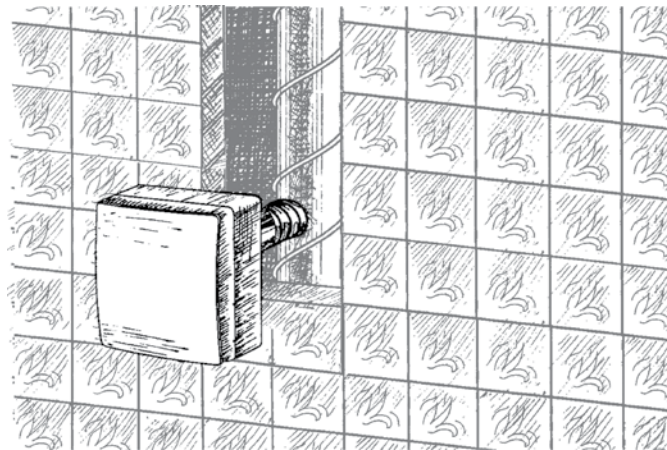

Overall dimensions [mm]

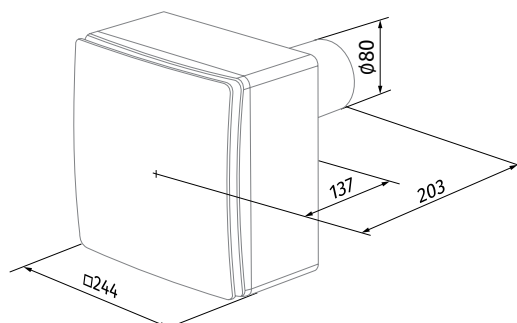

Technical data

Parameters	Valeo-E 60/100/150	Valeo-E 35/60	Valeo-E 35/100	Valeo-E 35/60/100	Valeo-E 60/100
Speeds	3	2	2	3	2
Voltage [V / 50 Hz]	220-240	220-240	220-240	220-240	220-240
Power [W]	17/27/48	12/17	12/27	12/17/27	17/27
Current [A]	0.14/0.18/0.21	0.12/0.14	0.12/0.18	0.12/0.14/0.18	0.14/0.18
Cable cross section [mm ²]	4x1.5	3x1.5	3x1.5	4x1.5	3x1.5
Maximum air flow [m ³ /h (l/s)]	63 (18) 102 (28) 150 (42)	35 (10) 63 (18)	35 (10) 102 (28)	35 (10) 63 (18) 102 (28)	63 (18) 102 (28)
RPM [min ⁻¹]	1350/1830/2640	890/1350	890/1830	890/1350/1830	1350/1830
Sound pressure at 3 m [dBA]	30/35.2/43.7	26.6/30	26.6/35.2	26.6/30/35.2	30/35.2
Max. transported air temperature [°C]	50	50	50	50	50
SEC class	-	-	-	-	-
Ingress protection rating	IP55	IP55	IP55	IP55	IP55
Motor IP rating	IP44	IP44	IP44	IP44	IP44
ErP	-	-	-	-	-

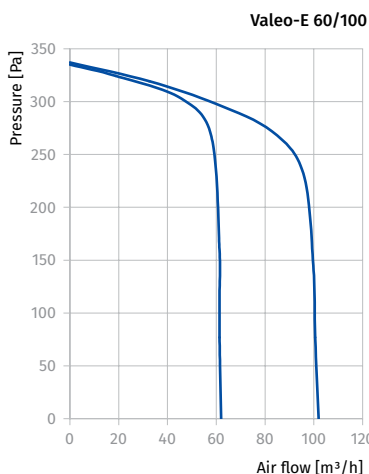
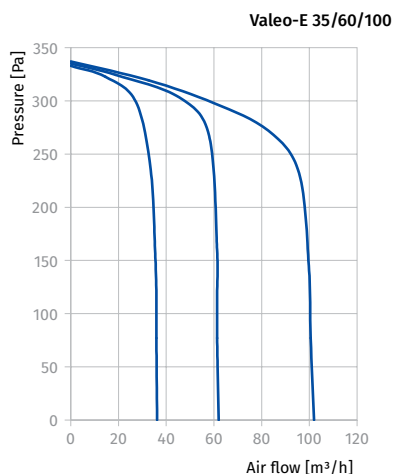
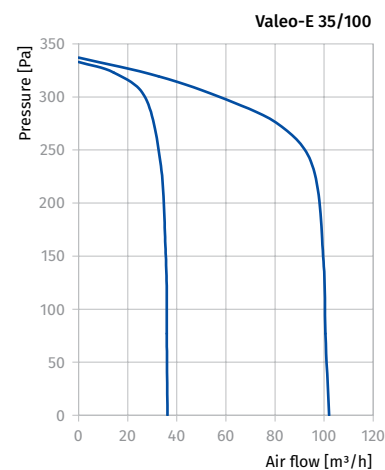
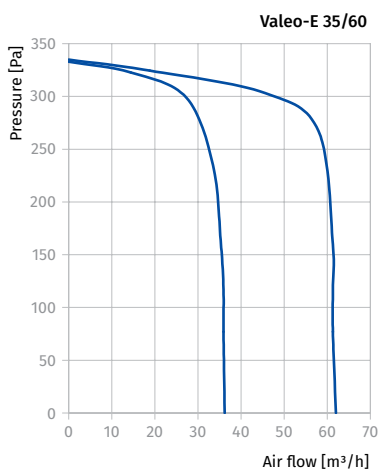
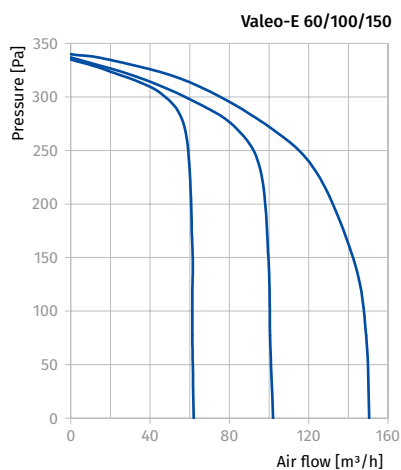

- The abrupt curves show high pressure performance and constant air flow of several Valeo-E fans integrated into a single ventilation shaft.
 - available pressure up to 270 Pa at 35 m³/h;
 - available pressure up to 260 Pa at 60 m³/h;
 - available pressure up to 220 Pa at 100 m³/h.

High-rise mono-pipe ventilation system arrangement example

- o The mechanical centralized mono-pipe exhaust ventilation system for kitchens and bathrooms based on Valeo-E fans is specially designed for high-rise residential premises.
- o Fresh air is supplied to bedrooms, children's room or living rooms through window or wall vents. Vent modifications with air volume regulation are available.
- o Stale air is extracted by exhaust fans from the room through inside doors or door grilles in the kitchen, bathroom or WC.
- o This ventilation system arrangement ensures non-stop controllable air circulation in the room, comfortable microclimate and high fire safety.

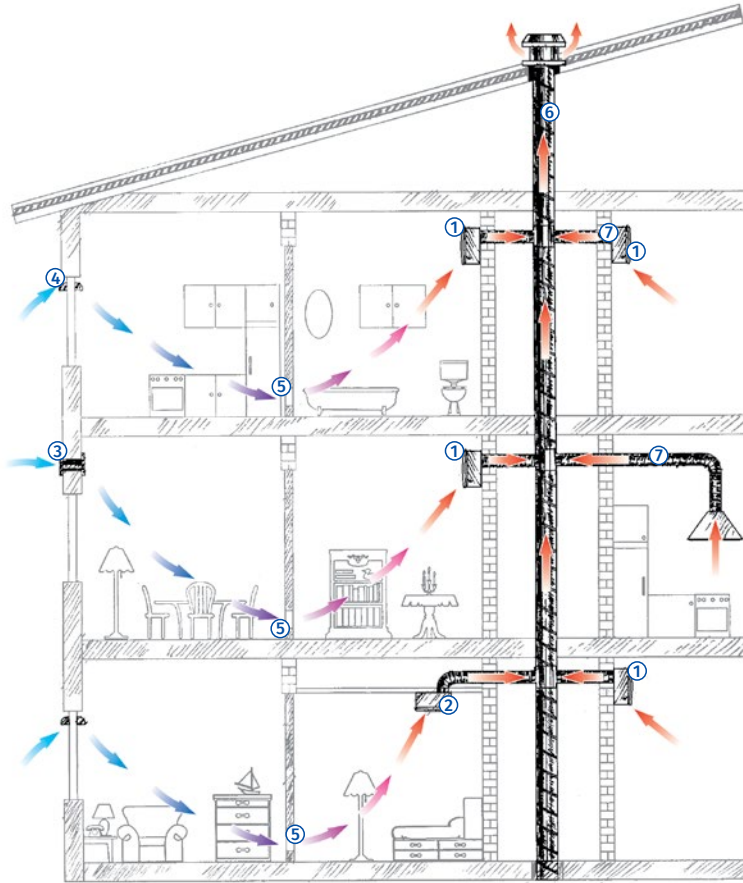

- 1 – Exhaust fan **Valeo-E** (surface mounting).
- 2 – Exhaust fan **Valeo-E** (ceiling mounting).
- 3 – BLAUBERG wall vent, **WMH** series.
- 4 – BLAUBERG window vent, **FHM** series.
- 5 – BLAUBERG ventilation grilles, **DECOR** series.
- 6 – Central ventilation shaft.
- 7 – Flexible air ducts for connection of exhaust fans to the central ventilation shaft, e.g. BLAUBERG air ducts, **Blauflex** series.